

ACCESORIOS



0007 - ENGANCHE CREMONA RF.0006

	SA	2,38
	LB	
	LC	
	LM	
	LV	
	EM	
	PL	
	PB	
	AC	

0015 - PASADOR PLANO 200

	SA	
	LB	
	LC	3,52
	LM	
	LV	
	EM	
	PL	
	PB	
	AC	

0033 - TAPETAS 4 HOJAS S/MAGNUM

	SA	
	LB	
	LC	0,47
	LM	
	LV	
	EM	
	PL	
	PB	
	AC	

0008 - PERNO TRANSMISION CREMONA

	SA	0,53
	LB	
	LC	
	LM	
	LV	
	EM	
	PL	
	PB	
	AC	

0030 - EMBELLECEDOR JUNQUILLO 25 MM.

	SA	0,52
	LB	0,92
	LC	0,92
	LM	2,88
	LV	1,53
	EM	1,13
	PL	0,53
	PB	
	AC	

0034 - BOMBILLO CERRADURA S/MAGNUM

	SA	71,57
	LB	
	LC	
	LM	
	LV	
	EM	
	PL	
	PB	
	AC	

0011 - CONJUNTO PERNIOS PIVOTANTE /1400

	SA	
	LB	60,50
	LC	60,50
	LM	
	LV	
	EM	
	PL	
	PB	
	AC	

0031 - CORTAVIENTOS S/MAGNUM

	SA	
	LB	
	LC	1,23
	LM	
	LV	
	EM	
	PL	
	PB	
	AC	















0036 - CONJ. CARRO Y PIEZAS EJECUCION 300

	SA	212,00
	LB	
	LC	
	LM	
	LV	
	EM	
	PL	
	PB	
	AC	

ACCESORIOS - TARIFA PVP - GRUPO AYUSO

Fecha de entrada en vigor: 01-03-2007

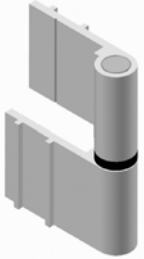
Moneda: Euro

0037 - MANILLA CORREDERA S/MAGNUM			0038-179 - FALLEBA DE 1190 A 1790 S/MAGNUM			0038-229 - FALLEBA DE 1791 A 2290 S/MAGNUM		
	SA			SA	112,90		SA	123,53
	LB	73,50		LB			LB	
	LC	73,50		LC			LC	
	LM			LM			LM	
	LV			LV			LV	
	EM			EM			EM	
	PL			PL			PL	
	PB			PB			PB	
	AC			AC			AC	
0038-269 - FALLEBA DE 2291 A 2690 S/MAGNUM			0039-150 - BARRA DE UNION DE 750 A 1500 S/MAG			0039-200 - BARRA DE UNION DE 1501 A 2000 S/MAG		
	SA	139,40		SA	7,07		SA	11,03
	LB			LB			LB	
	LC			LC			LC	
	LM			LM			LM	
	LV			LV			LV	
	EM			EM			EM	
	PL			PL			PL	
	PB			PB			PB	
	AC			AC			AC	
0039-250 - BARRA DE UNION DE 2001 A 2500 S/MAG			0039-300 - BARRA DE UNION DE 2501 A 3000 S/MAG			0040 - CONJUNTO TAPA RAN. H. C, S/MAGNUM		
	SA	14,63		SA	19,17		SA	
	LB			LB			LB	
	LC			LC			LC	2,34
	LM			LM			LM	
	LV			LV			LV	
	EM			EM			EM	
	PL			PL			PL	
	PB			PB			PB	
	AC			AC			AC	
0042 - COMPLEMENTO PARA 400 KG.(CM 300)			0043 - COMPLEMENTO PARA 400 KG.(BU 4 T)			0044 - COMPLEMENTO PARA 400 KG.(R 616)		
	SA	111,93		SA	9,73		SA	1,77
	LB			LB			LB	
	LC			LC			LC	
	LM			LM			LM	
	LV			LV			LV	
	EM			EM			EM	
	PL			PL			PL	
	PB			PB			PB	
	AC			AC			AC	
0045 - PERNIO MAMPARA OFICINA DH.			0046 - PERNIO MAMPARA OFICINA IZ.			0047 - CONJUNTO MANILLAS S/MAGNUM		
	SA			SA			SA	
	LB	2,65		LB	2,65		LB	146,67
	LC	2,65		LC	2,65		LC	146,67
	LM			LM			LM	
	LV	3,13		LV	3,13		LV	
	EM			EM			EM	
	PL	2,65		PL	2,65		PL	
	PB			PB			PB	
	AC			AC			AC	

ACCESORIOS - TARIFA PVP - GRUPO AYUSO

Fecha de entrada en vigor: 01-03-2007

Moneda: Euro

0048 - CONJUN. JUNTA ESTANQUEIDAD S/MAGNUM

	SA	0,30
	LB	
	LC	
	LM	
	LV	
	EM	
	PL	
	PB	
	AC	

0049 - NUDO ESQUINA OFICINA CRISTAL

	SA	12,40
	LB	
	LC	
	LM	
	LV	16,24
	EM	
	PL	
	PB	
	AC	

0050 - BISAGRA OFICINA CRISTAL

	SA	44,20
	LB	
	LC	
	LM	
	LV	55,88
	EM	
	PL	
	PB	
	AC	

0051 - CONJU. SUJECI.1 CERCO OFIC. CRISTAL

	SA	
	LB	
	LC	
	LM	
	LV	6,53
	EM	
	PL	
	PB	
	AC	

0052 - CONJUNTO TACOS HOJA FIJA (4 UND.)

	SA	
	LB	
	LC	1,40
	LM	
	LV	
	EM	
	PL	
	PB	
	AC	

0054 - GOMA DIV. OFIC. CRISTAL

	SA	
	LB	
	LC	0,38
	LM	
	LV	
	EM	
	PL	
	PB	
	AC	

0055 - CIERRE PRESION DE RODILLO DERECHA

	SA	
	LB	7,37
	LC	7,37
	LM	
	LV	
	EM	
	PL	
	PB	
	AC	

0056 - CIERRE PRESION DE RODILLO IZQUIERDA

	SA	
	LB	7,37
	LC	7,37
	LM	
	LV	
	EM	
	PL	
	PB	
	AC	

0057 - CIERRE GOLPETE

	SA	
	LB	2,30
	LC	2,30
	LM	
	LV	
	EM	
	PL	
	PB	
	AC	

0060 - COMPAS BASCULANTE

	SA	
	LB	
	LC	1,97
	LM	
	LV	
	EM	
	PL	
	PB	
	AC	

0063 - ESCUADRA TORNILLO S/1400 PUERTA

	SA	2,43
	LB	
	LC	
	LM	
	LV	
	EM	
	PL	
	PB	
	AC	

0064 - ESCUADRA TORNILLO S/1400 VENTANA

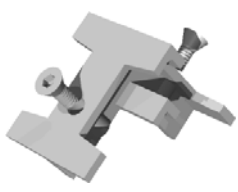
	SA	1,53
	LB	
	LC	
	LM	
	LV	
	EM	
	PL	
	PB	
	AC	

0067 - TACO TORNILLO S/1400 VENTANA

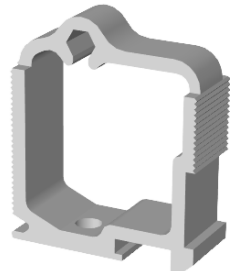
	SA	0,99
	LB	
	LC	
	LM	
	LV	
	EM	
	PL	
	PB	
	AC	

0068 - TACO TORNILLO S/1400 PUERTA

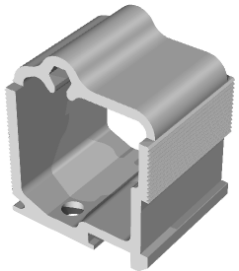
	SA	1,22
	LB	
	LC	
	LM	
	LV	
	EM	
	PL	
	PB	
	AC	

0073 - PASADOR 100

	SA	
	LB	2,67
	LC	2,67
	LM	
	LV	
	EM	
	PL	
	PB	
	AC	

ACCESORIOS - TARIFA PVP - GRUPO AYUSO

Fecha de entrada en vigor: 01-03-2007

Moneda: Euro

0075 - PASADOR DE 200			0077 - PASADOR 300			0085 - JUEGO TIRADOR STYLE 350 MM.		
	SA			SA			SA	
	LB	3,77		LB	4,47		LB	50,38
	LC	3,77		LC	4,47		LC	50,38
	LM			LM			LM	
	LV			LV			LV	
	EM			EM			EM	
	PL			PL			PL	50,38
	PB			PB			PB	
	AC			AC			AC	50,38
0091 - CERRADERO DE ALUMINIO			0099 - TAPON PVC TUBO 30X15 Y ALFEIZAR			0108 - TENSOR DE OFICINA CON TORNILLO		
	SA			SA			SA	0,84
	LB			LB	0,20		LB	
	LC	1,78		LC	0,20		LC	
	LM			LM			LM	
	LV			LV			LV	
	EM			EM			EM	
	PL			PL			PL	
	PB			PB			PB	
	AC			AC			AC	
0109 - REMATE PASAMANOS			0111 - CIERRE PULSADOR CON CERRADURA			0120 - CONJUNTO TAPONES INVERSORA S/1450		
	SA			SA			SA	
	LB	4,19		LB			LB	
	LC	4,19		LC			LC	1,03
	LM			LM			LM	
	LV			LV			LV	
	EM			EM			EM	
	PL	4,31		PL	10,83		PL	
	PB			PB			PB	
	AC	4,31		AC			AC	
0123 - CONJUNTO TAPONES INVERSORA S/1400			0126 - ESCUADRA TENSOR CAMARA 30X15			0127 - ESCUADRA TENSOR CAMARA 30X31,6		
	SA			SA	0,84		SA	1,09
	LB			LB			LB	
	LC	1,03		LC			LC	
	LM			LM			LM	
	LV			LV			LV	
	EM			EM			EM	
	PL			PL			PL	
	PB			PB			PB	
	AC			AC			AC	
0132 - ESCUADRA TENSOR CAMARA 37X15			0134 - KIT ESCUADRAS MOSQUITERA			0135 - ESCUADRA TENSOR CAMARA 18X11		
	SA	0,91		SA	2,26		SA	0,63
	LB			LB			LB	
	LC			LC			LC	
	LM			LM			LM	
	LV			LV			LV	
	EM			EM			EM	
	PL			PL			PL	
	PB			PB			PB	
	AC			AC			AC	

ACCESORIOS - TARIFA PVP - GRUPO AYUSO

Fecha de entrada en vigor: 01-03-2007

Moneda: Euro

0144 - ESCUADRA TENSOR CAMARA 37X31,6		
	SA	1,25
	LB	
	LC	
	LM	
	LV	
	EM	
	PL	
	PB	
	AC	

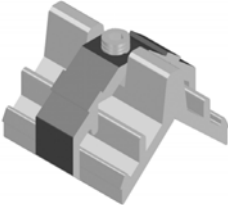
0147 - ESCUADRA TENSOR CAMARA 37X11		
	SA	0,78
	LB	
	LC	
	LM	
	LV	
	EM	
	PL	
	PB	
	AC	

0148 - ESCUADRA CERCO 3 CARRILES		
	SA	1,09
	LB	
	LC	
	LM	
	LV	
	EM	
	PL	
	PB	
	AC	

0149 - ESCUADRA TETON CAMARA 37X15		
	SA	0,94
	LB	
	LC	
	LM	
	LV	
	EM	
	PL	
	PB	
	AC	

0150 - ESCUADRA TETONES CAMARA 37X16,4		
	SA	1,10
	LB	
	LC	
	LM	
	LV	
	EM	
	PL	
	PB	
	AC	

0151 - ESCUADRA PVC. 37X16 PREMARCO CORRED		
	SA	
	LB	
	LC	0,20
	LM	
	LV	
	EM	
	PL	
	PB	
	AC	

0152 - ESCUADRA PVC. 24X16 PREMARCO ABATI		
	SA	
	LB	
	LC	0,16
	LM	
	LV	
	EM	
	PL	
	PB	
	AC	

0162 - EMBELLECEDOR LUMINOSO		
	SA	3,02
	LB	
	LC	
	LM	
	LV	
	EM	
	PL	
	PB	
	AC	

0163 - ESQUINERO REDONDO LUMINOSO		
	SA	1,57
	LB	
	LC	
	LM	
	LV	
	EM	
	PL	
	PB	
	AC	

0164 - KIT MALLORQUINA 1 HOJA		
	SA	
	LB	19,62
	LC	19,62
	LM	
	LV	
	EM	
	PL	
	PB	
	AC	

0165 - GRILLO PARA MALLORQUINA		
	SA	
	LB	7,66
	LC	7,66
	LM	
	LV	
	EM	
	PL	
	PB	
	AC	

0166 - KIT MALLORQUINA 2 HOJAS		
	SA	
	LB	23,20
	LC	23,20
	LM	
	LV	
	EM	
	PL	
	PB	
	AC	

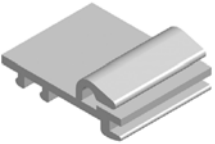
0167 - GRAPA JUNQUILLO S/1400 Y 1450		
	SA	0,10
	LB	
	LC	
	LM	
	LV	
	EM	
	PL	
	PB	
	AC	

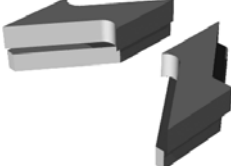
0170 - CONJUNTO TAPONES MALLORQUINA INTERM		
	SA	
	LB	0,33
	LC	0,33
	LM	
	LV	
	EM	
	PL	
	PB	
	AC	

0171 - CONJUNTO TAPONES MALLORQUINA FINAL		
	SA	
	LB	0,43
	LC	0,43
	LM	
	LV	
	EM	
	PL	
	PB	
	AC	

ACCESORIOS - TARIFA PVP - GRUPO AYUSO

Fecha de entrada en vigor: 01-03-2007

Moneda: Euro

0182 - CONJ. PLAST. BARRA DESAGÜE BAÑERA

	SA	
	LB	2,50
	LC	
	LM	
	LV	
	EM	
	PL	
	PB	
	AC	

0189 - KIT S/1400 Y 1450 UNA HOJA DH.

	SA	
	LB	21,31
	LC	21,31
	LM	
	LV	
	EM	
	PL	
	PB	
	AC	

0190 - KIT S/1400 Y 1450 UNA HOJA IZ.

	SA	
	LB	21,31
	LC	21,31
	LM	
	LV	
	EM	
	PL	
	PB	
	AC	

0191 - KIT S/1400 DOS HOJAS

	SA	
	LB	28,21
	LC	28,21
	LM	
	LV	
	EM	
	PL	
	PB	
	AC	

0192 - KIT S/1450 DOS HOJAS

	SA	
	LB	28,21
	LC	28,21
	LM	
	LV	
	EM	
	PL	
	PB	
	AC	

0193 - CONJ. CIER. CRE. PVC. S/1400 Y 1450

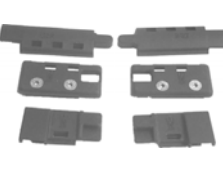
	SA	
	LB	
	LC	3,03
	LM	
	LV	
	EM	
	PL	
	PB	
	AC	

0196 - CERROJO HOJA PASIVA S/1400 Y 1450

	SA	
	LB	
	LC	3,56
	LM	
	LV	
	EM	
	PL	
	PB	
	AC	

0197 - PERNIO EMPALME CON CREMONA OSCILO

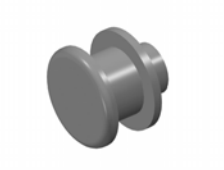
	SA	0,84
	LB	
	LC	
	LM	
	LV	
	EM	
	PL	
	PB	
	AC	

0198 - BULON PUNTO CIERRE OSCILO

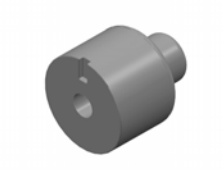
	SA	0,93
	LB	
	LC	
	LM	
	LV	
	EM	
	PL	
	PB	
	AC	

0200 - ENGANCHE CREMONA

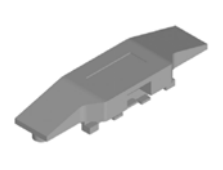
	SA	1,93
	LB	
	LC	
	LM	
	LV	
	EM	
	PL	
	PB	
	AC	

0201 - KIT BASE 2 HOJAS

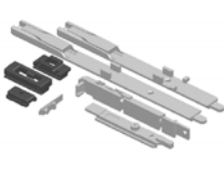
	SA	27,91
	LB	
	LC	
	LM	
	LV	
	EM	
	PL	
	PB	
	AC	

0202 - CONJUNTO BISAGRAS OSCILO

	SA	24,63
	LB	24,82
	LC	24,82
	LM	
	LV	28,53
	EM	
	PL	35,20
	PB	
	AC	35,20

0203 - UND. PERNIO HOJA PASIVA

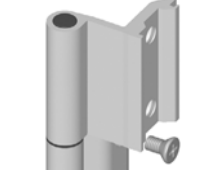
	SA	3,00
	LB	3,27
	LC	3,27
	LM	
	LV	
	EM	
	PL	
	PB	
	AC	

0204 - COMPAS HOJAS DE 361 A 600

	SA	22,22
	LB	
	LC	
	LM	
	LV	
	EM	
	PL	
	PB	
	AC	

0205 - COMPAS HOJAS DE 400 A 650

	SA	20,35
	LB	
	LC	
	LM	
	LV	
	EM	
	PL	
	PB	
	AC	

ACCESORIOS - TARIFA PVP - GRUPO AYUSO

Fecha de entrada en vigor: 01-03-2007

Moneda: Euro

0206 - COMPAS HOJAS DE 570 A 1200			0207 - ANGULO DE REENVIO			0208 - KIT BASE 1 HOJA		
	SA	20,94		SA	13,44		SA	22,31
	LB			LB			LB	
	LC			LC			LC	
	LM			LM			LM	
	LV			LV			LV	
	EM			EM			EM	
	PL			PL			PL	
	PB			PB			PB	
	AC			AC			AC	
0209 - KIT OSCILO EURO 2 H.TERMIC			0210 - KIT OSCILO EURO 1 H.TERMIC			0211 - KIT OSCILO EURO 2 H.PRACTIC		
	SA			SA			SA	
	LB	95,74		LB	75,84		LB	97,11
	LC	95,74		LC	75,84		LC	97,11
	LM			LM			LM	
	LV			LV			LV	
	EM			EM			EM	
	PL	124,31		PL	96,18		PL	125,10
	PB			PB			PB	
	AC	124,76		AC	96,63		AC	125,56
0212 - KIT OSCILO EURO 1 H.PRACTIC			0213 - UND. BISAGRA HOJA PASIVA			0214 - KIT OSCILO EURO 2 HOJAS		
	SA			SA	6,14		SA	
	LB	76,36		LB	6,66		LB	77,22
	LC	76,36		LC	6,66		LC	77,22
	LM			LM			LM	
	LV			LV	9,18		LV	
	EM			EM			EM	
	PL	96,74		PL	13,72		PL	107,39
	PB			PB			PB	
	AC	97,19		AC	13,72		AC	103,60
0215 - KIT OSCILO EURO 1 HOJA			0216 - KIT 2 H. S/PRACTIC OSCILO CAM. 11MM			0217 - KIT 1 H. S/PRACTIC OSCILO CAM.11 MM		
	SA			SA			SA	
	LB	64,38		LB	95,55		LB	73,99
	LC	64,38		LC	95,55		LC	73,99
	LM			LM			LM	
	LV			LV			LV	
	EM			EM			EM	
	PL	83,13		PL	126,87		PL	96,10
	PB			PB			PB	
	AC	83,57		AC	123,89		AC	94,65
0218-1000 - CORTAVIENTOS AUTOMATICO 1000 MM.			0218-800 - CORTAVIENTOS AUTOMATICO 800 MM.			0218-8012 - MECANISMO CENTRAL 1 PUNTO DE CIERRE		
	SA	22,80		SA	20,80		SA	
	LB			LB			LB	
	LC			LC			LC	58,50
	LM			LM			LM	
	LV			LV			LV	
	EM			EM			EM	
	PL			PL			PL	
	PB			PB			PB	
	AC			AC			AC	

ACCESORIOS - TARIFA PVP - GRUPO AYUSO

Fecha de entrada en vigor: 01-03-2007

Moneda: Euro

0218-8020 - MECANISMO CENTRAL 2 PUNTOS DE CIERR

	SA	
	LB	
	LC	44,60
	LM	
	LV	
	EM	
	PL	
	PB	
	AC	

0218-8040 - SOPORTE CENTRAL

	SA	
	LB	
	LC	50,00
	LM	
	LV	
	EM	
	PL	
	PB	
	AC	

0218-8100 - BARRA

	SA	
	LB	
	LC	14,10
	LM	
	LV	
	EM	
	PL	
	PB	
	AC	

0218-8400 - PESTILLO VERTICAL

	SA	
	LB	
	LC	20,50
	LM	
	LV	
	EM	
	PL	
	PB	
	AC	

0218-8405 - CERRADERO SUPERIOR

	SA	
	LB	
	LC	8,20
	LM	
	LV	
	EM	
	PL	
	PB	
	AC	

0218-8442 - VARILLA DE CONEXION CON TAPONES

	SA	
	LB	
	LC	12,00
	LM	
	LV	
	EM	
	PL	
	PB	
	AC	

0218-8500 - CERRADERO REGULABLE

	SA	
	LB	
	LC	9,00
	LM	
	LV	
	EM	
	PL	
	PB	
	AC	

0218-8540 - CERADERO DE SUELO

	SA	
	LB	
	LC	7,60
	LM	
	LV	
	EM	
	PL	
	PB	
	AC	

0218-8570 - MANILLA EXTERIOR CON CERRADURA

	SA	
	LB	
	LC	63,80
	LM	
	LV	
	EM	
	PL	
	PB	
	AC	

0218-900 - CORTAVIENTOS AUTOMATICO 900 MM.

	SA	22,00
	LB	
	LC	
	LM	
	LV	
	EM	
	PL	
	PB	
	AC	

0218-A - PLASTICOS INVERSORA SECURITY DOOR

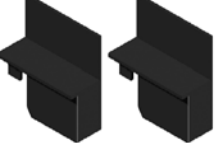
	SA	
	LB	
	LC	0,37
	LM	
	LV	
	EM	
	PL	
	PB	
	AC	

0218-B - BISAGRA 3 PALAS SECURITY DOOR

	SA	
	LB	24,23
	LC	24,23
	LM	
	LV	
	EM	
	PL	60,90
	PB	
	AC	

0218-C - CERROJO HOJA PASIVA SECURITY DOOR

	SA	16,33
	LB	
	LC	
	LM	
	LV	
	EM	
	PL	
	PB	
	AC	

0218-D - PROLONGACION CERROJO 0218-C

	SA	
	LB	
	LC	4,56
	LM	
	LV	
	EM	
	PL	
	PB	
	AC	

0218-E - CERRADERO 11 MM. SECURITY DOOR

	SA	7,00
	LB	
	LC	
	LM	
	LV	
	EM	
	PL	
	PB	
	AC	

ACCESORIOS - TARIFA PVP - GRUPO AYUSO

Fecha de entrada en vigor: 01-03-2007

Moneda: Euro

0218-F - CERRADERO 14 MM.SECURITY DOOR

	SA	7,00
	LB	
	LC	
	LM	
	LV	
	EM	
	PL	
	PB	
	AC	

0218-G - CERRADERO 13 MM.SECURITY DOOR

	SA	7,17
	LB	
	LC	
	LM	
	LV	
	EM	
	PL	
	PB	
	AC	

0218-H - ENCUESTRO CERROJO SUP.SECURITI DOOR

	SA	7,33
	LB	
	LC	
	LM	
	LV	
	EM	
	PL	
	PB	
	AC	

0218-J - KIT CE/AN PUNTO CIERRE SU/IN.

	SA	
	LB	
	LC	189,31
	LM	
	LV	
	EM	
	PL	
	PB	
	AC	

0218-L - KIT CE/AN PUNTO CIERRE CENTRAL

	SA	
	LB	
	LC	131,47
	LM	
	LV	
	EM	
	PL	
	PB	
	AC	

0219-0640B - MANILLA S/ ATLANTIC

	SA	
	LB	12,18
	LC	12,18
	LM	
	LV	
	EM	
	PL	
	PB	
	AC	

0219-1701A - MECANISMO MANILLA SIN FALSA MANIOBR

	SA	10,00
	LB	
	LC	
	LM	
	LV	
	EM	
	PL	
	PB	
	AC	

0219-1701B - MECANISMO MANILLA CON FALSA MANIOBR

	SA	11,77
	LB	
	LC	
	LM	
	LV	
	EM	
	PL	
	PB	
	AC	

0219-1705D - BISAGRA INFERIOR PARTE MARCO DH.

	SA	
	LB	4,83
	LC	4,83
	LM	
	LV	
	EM	
	PL	
	PB	
	AC	

0219-1705S - BISAGRA INFERIOR PARTE MARCO IZ.

	SA	
	LB	4,83
	LC	4,83
	LM	
	LV	
	EM	
	PL	
	PB	
	AC	

0219-1706D - BISAGRA SUPERIOR PARTE MARCO DH.

	SA	
	LB	6,73
	LC	6,73
	LM	
	LV	
	EM	
	PL	
	PB	
	AC	

0219-1706S - BISAGRA SUPERIOR PARTE MARCO IZ.

	SA	
	LB	6,73
	LC	6,73
	LM	
	LV	
	EM	
	PL	
	PB	
	AC	

0219-1707D - BISAGRA INFERIOR PARTE HOJA DH.

	SA	
	LB	6,73
	LC	6,73
	LM	
	LV	
	EM	
	PL	
	PB	
	AC	

0219-1707S - BISAGRA INFERIOR PARTE HOJA IZ.

	SA	
	LB	6,73
	LC	6,73
	LM	
	LV	
	EM	
	PL	
	PB	
	AC	

0219-1708 - FALSA COMPAS

	SA	
	LB	7,70
	LC	7,70
	LM	
	LV	
	EM	
	PL	
	PB	
	AC	

ACCESORIOS - TARIFA PVP - GRUPO AYUSO

Fecha de entrada en vigor: 01-03-2007

Moneda: Euro

0219-1709D - BISAGRA CERCO PRACTICABLE DH.

	SA	
	LB	2,13
	LC	2,13
	LM	
	LV	
	EM	
	PL	
	PB	
	AC	

0219-1709S - BISAGRA CERCO PRACTICABLE IZ.

	SA	
	LB	2,13
	LC	2,13
	LM	
	LV	
	EM	
	PL	
	PB	
	AC	

0219-1710D - BISAGRA HOJA PRACTICABLE DH.

	SA	
	LB	1,93
	LC	1,93
	LM	
	LV	
	EM	
	PL	
	PB	
	AC	

0219-1710S - BISAGRA HOJA PRACTICABLE IZ.

	SA	
	LB	1,93
	LC	1,93
	LM	
	LV	
	EM	
	PL	
	PB	
	AC	

0219-1712 - CIERRE HOJA PASIVA PIEZA CERCO

	SA	1,73
	LB	
	LC	
	LM	
	LV	
	EM	
	PL	
	PB	
	AC	

0219-1713 - CIERRE HOJA PASIVA PIEZA HOJA

	SA	1,73
	LB	
	LC	
	LM	
	LV	
	EM	
	PL	
	PB	
	AC	

0219-1715A - COMPAS CORTO

	SA	
	LB	14,43
	LC	14,43
	LM	
	LV	
	EM	
	PL	
	PB	
	AC	

0219-1715B - COMPAS MEDIO

	SA	
	LB	17,33
	LC	17,33
	LM	
	LV	
	EM	
	PL	
	PB	
	AC	

0219-1715C - COMPAS LARGO

	SA	
	LB	20,23
	LC	20,23
	LM	
	LV	
	EM	
	PL	
	PB	
	AC	

0219-1720 - CERRADERO PARA COMPAS

	SA	2,23
	LB	
	LC	
	LM	
	LV	
	EM	
	PL	
	PB	
	AC	

0219-1722 - ANGULO REENVIO Y CIERRE PARA COMPAS

	SA	6,93
	LB	
	LC	
	LM	
	LV	
	EM	
	PL	
	PB	
	AC	

0219-1725 - ANGULO DE REENVIO

	SA	6,53
	LB	
	LC	
	LM	
	LV	
	EM	
	PL	
	PB	
	AC	

0219-1728 - TERMINAL PLETINA CON SOSTEN HOJA

	SA	2,80
	LB	
	LC	
	LM	
	LV	
	EM	
	PL	
	PB	
	AC	

0219-1730 - ANGULO REENVIO SUPLEM. CON TERMINAL

	SA	8,30
	LB	
	LC	
	LM	
	LV	
	EM	
	PL	
	PB	
	AC	

0219-1735D - CERRADERO INFERIOR DE ANGULO DH.

	SA	0,63
	LB	
	LC	
	LM	
	LV	
	EM	
	PL	
	PB	
	AC	

ACCESORIOS - TARIFA PVP - GRUPO AYUSO

Fecha de entrada en vigor: 01-03-2007

Moneda: Euro

0219-1735S - CERRADERO INFERIOR DE ANGULO IZ.

	SA	0,63
	LB	
	LC	
	LM	
	LV	
	EM	
	PL	
	PB	
	AC	

0219-1740 - PUNTO DE CIERRE

	SA	1,43
	LB	
	LC	
	LM	
	LV	
	EM	
	PL	
	PB	
	AC	

0219-1745 - ENGANCHE CERRADERO

	SA	1,17
	LB	
	LC	
	LM	
	LV	
	EM	
	PL	
	PB	
	AC	

0219-1748 - PATIN APOYO DE HOJA

	SA	0,33
	LB	
	LC	
	LM	
	LV	
	EM	
	PL	
	PB	
	AC	

0219-1751 - TERMINAL PLETINA PARA APERTURA 2 H.

	SA	1,80
	LB	
	LC	
	LM	
	LV	
	EM	
	PL	
	PB	
	AC	

0219-1753D - PASADOR HOJA PASIVA DH.

	SA	4,07
	LB	
	LC	
	LM	
	LV	
	EM	
	PL	
	PB	
	AC	

0219-1753S - PASADOR HOJA PASIVA IZ.

	SA	4,07
	LB	
	LC	
	LM	
	LV	
	EM	
	PL	
	PB	
	AC	

0219-1758 - ENGANCHE CERRADERO DOBLE

	SA	70,00
	LB	
	LC	
	LM	
	LV	
	EM	
	PL	
	PB	
	AC	

0219-1785 - COMPAS BASCULANTE

	SA	7,60
	LB	
	LC	
	LM	
	LV	
	EM	
	PL	
	PB	
	AC	

0219-1787 - CIERRE GOLPETE

	SA	
	LB	9,43
	LC	9,43
	LM	
	LV	
	EM	
	PL	
	PB	
	AC	

0219-A - CONJUNTO TAPON INVERSORA S/ATLANTIC

	SA	
	LB	
	LC	1,27
	LM	
	LV	
	EM	
	PL	
	PB	
	AC	

0219-B - GOMA JUNTA INTERIOR S/ATLANTIC

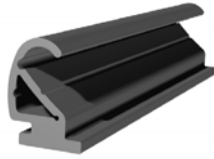
	SA	
	LB	
	LC	0,71
	LM	
	LV	
	EM	
	PL	
	PB	
	AC	

0219-C - GOMA JUNTA CENTRAL S/ATLANTIC

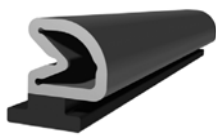
	SA	
	LB	
	LC	0,63
	LM	
	LV	
	EM	
	PL	
	PB	
	AC	

0219-D - GOMA JUNQUILLO S/ATLANTIC

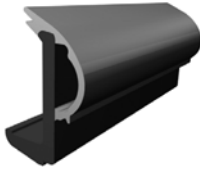
	SA	
	LB	
	LC	1,44
	LM	
	LV	
	EM	
	PL	
	PB	
	AC	

0219-E - ESCUADRA DE ALINEACION

	SA	1,13
	LB	
	LC	
	LM	
	LV	
	EM	
	PL	
	PB	
	AC	

ACCESORIOS - TARIFA PVP - GRUPO AYUSO

Fecha de entrada en vigor: 01-03-2007

Moneda: Euro

0220 - ESCUADRA TETONES S/SECURITY DOOR

	SA	1,91
	LB	
	LC	
	LM	
	LV	
	EM	
	PL	
	PB	
	AC	

0233 - NUDO SOLAPE 6085

	SA	2,03
	LB	2,28
	LC	2,28
	LM	
	LV	
	EM	
	PL	
	PB	
	AC	

0239 - ESCUADRA GOMA ESTANQU. S/PRACTIC 45

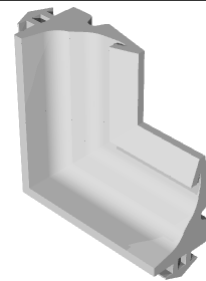
	SA	
	LB	
	LC	0,28
	LM	
	LV	
	EM	
	PL	
	PB	
	AC	

0240 - GOMA ESTANQ. CERCO S/P 45 100 MT.

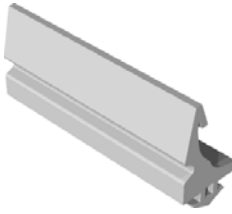
	SA	
	LB	
	LC	76,06
	LM	
	LV	
	EM	
	PL	
	PB	
	AC	

0241 - CREMONA APERTURA EXTERIOR

	SA	
	LB	14,70
	LC	14,70
	LM	
	LV	
	EM	
	PL	
	PB	
	AC	

0242 - CERRADERO

	SA	
	LB	2,98
	LC	2,98
	LM	
	LV	
	EM	
	PL	
	PB	
	AC	

0243 - CERRADERO SUELO

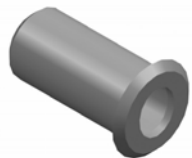
	SA	4,69
	LB	
	LC	
	LM	
	LV	
	EM	
	PL	
	PB	
	AC	

0244 - SOPORTE VARILLA

	SA	0,84
	LB	
	LC	
	LM	
	LV	
	EM	
	PL	
	PB	
	AC	

0245 - EMBELLECEDOR + VARILLA 1800 MM.

	SA	
	LB	12,56
	LC	12,56
	LM	
	LV	
	EM	
	PL	
	PB	
	AC	

0246 - EMBELLECEDOR + VARILLA 1000 MM.

	SA	
	LB	8,59
	LC	8,59
	LM	
	LV	
	EM	
	PL	
	PB	
	AC	

0247 - EMBELLECEDOR + VARILLA 1400 MM.

	SA	
	LB	10,63
	LC	10,63
	LM	
	LV	
	EM	
	PL	
	PB	
	AC	

0249 - KIT ACCESORIOS PARA 1 MARCO

	SA	3,48
	LB	
	LC	
	LM	
	LV	
	EM	
	PL	
	PB	
	AC	

0250 - CONJUNTO ESCUADRAS 2 HOJAS EURO PER

 4 UNDS. 4 UNDS.	SA	9,22
	LB	
	LC	
	LM	
	LV	
	EM	
	PL	
	PB	
	AC	

0251 - ESCUADRA CERCO S/EURO PER

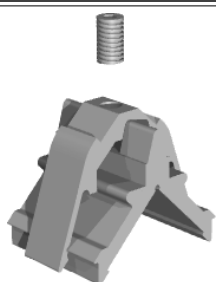
	SA	1,09
	LB	
	LC	
	LM	
	LV	
	EM	
	PL	
	PB	
	AC	

0252 - CIERRE S/EURO PER

	SA	
	LB	4,50
	LC	4,50
	LM	
	LV	
	EM	
	PL	6,95
	PB	
	AC	7,40

ACCESORIOS - TARIFA PVP - GRUPO AYUSO

Fecha de entrada en vigor: 01-03-2007

Moneda: Euro

0253 - CONJUNTO PLASTICOS 2 HOJAS EURO PER

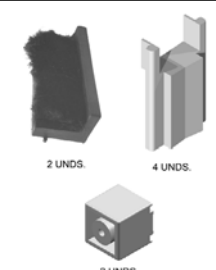
 <p>2 UNDS. 4 UNDS. 2 UNDS.</p>	SA	
	LB	2,56
	LC	2,56
	LM	
	LV	
	EM	
	PL	
	PB	
	AC	

0254 - KIT 2 HOJAS S/EURO PER

	SA	
	LB	26,86
	LC	26,86
	LM	
	LV	
	EM	
	PL	32,90
	PB	
	AC	33,83

0255 - KIT 15 VENTANAS S/EURO PER

	SA	
	LB	365,82
	LC	365,82
	LM	
	LV	
	EM	
	PL	
	PB	
	AC	

0256 - TAPETA 4 HOJAS S/EURO PER

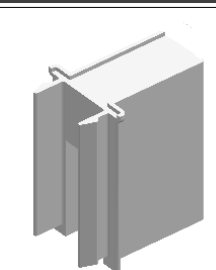
	SA	
	LB	0,30
	LC	0,30
	LM	
	LV	
	EM	
	PL	
	PB	
	AC	

0257 - CONJUNTO TAPONES 2 H. CENTRO S/PER

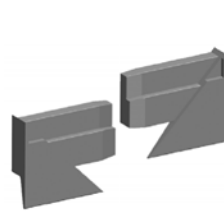
	SA	
	LB	0,72
	LC	0,72
	LM	
	LV	
	EM	
	PL	
	PB	
	AC	

0258 - TERMINAL RECTO APERTURA EXTERIOR

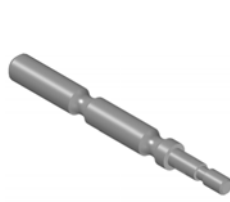
	SA	1,17
	LB	
	LC	
	LM	
	LV	
	EM	
	PL	
	PB	
	AC	

0259 - TERMINAL CURVO APERTURA EXTERIOR

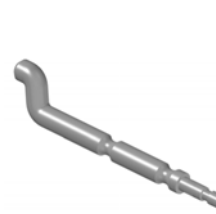
	SA	3,23
	LB	
	LC	
	LM	
	LV	
	EM	
	PL	
	PB	
	AC	

0263 - ESCUADRA TETON CAMARA 30X15

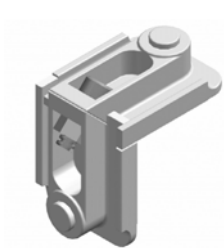
	SA	0,97
	LB	
	LC	
	LM	
	LV	
	EM	
	PL	
	PB	
	AC	

0264 - ESCUADRA TETON CAMARA 30X31,6

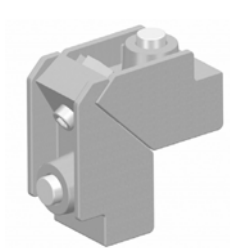
	SA	1,63
	LB	
	LC	
	LM	
	LV	
	EM	
	PL	
	PB	
	AC	

0265 - ESCUADRA TETON CAMARA 17X15

	SA	1,15
	LB	
	LC	
	LM	
	LV	
	EM	
	PL	
	PB	
	AC	

0266 - CONJUNTO TAPONES INVERSORA (PT 50)

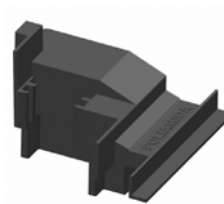
	SA	
	LB	
	LC	1,03
	LM	
	LV	
	EM	
	PL	
	PB	
	AC	

0267 - CONJUNTO TAPONES INVERSORA (PT60)

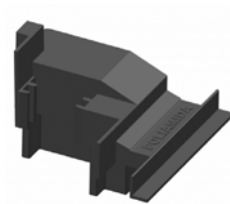
	SA	
	LB	
	LC	1,13
	LM	
	LV	
	EM	
	PL	
	PB	
	AC	

0268 - PERNIO EURO 90 MM.DH-IZ. MONOBLOCK

	SA	2,54
	LB	2,97
	LC	2,97
	LM	
	LV	3,33
	EM	
	PL	
	PB	
	AC	

0269 - PERNIO DESMONTADO EURO 90 MM.DH-IZ.

	SA	2,54
	LB	2,98
	LC	2,98
	LM	
	LV	3,33
	EM	
	PL	6,30
	PB	
	AC	6,30

0270 - KIT PRACTICABLE 1 HOJAS S/EURO

	SA	
	LB	26,08
	LC	26,08
	LM	
	LV	
	EM	
	PL	39,50
	PB	
	AC	39,87

ACCESORIOS - TARIFA PVP - GRUPO AYUSO

Fecha de entrada en vigor: 01-03-2007

Moneda: Euro

0271 - KIT PRACTICABLE 1 HOJA 15 V, S/EURO

	SA	
	LB	343,35
	LC	343,35
	LM	
	LV	
	EM	
	PL	
	PB	
	AC	

0272 - KIT PRACTICABLE 2 HOJAS S/EURO

	SA	
	LB	34,03
	LC	34,03
	LM	
	LV	
	EM	
	PL	53,90
	PB	
	AC	54,33

0273 - KIT PRACTICABLE 2 HOJA 15 V, S/EURO

	SA	
	LB	454,74
	LC	454,74
	LM	
	LV	
	EM	
	PL	
	PB	
	AC	

0274 - CORTAVIENTOS S/CT 70

	SA	0,81
	LB	
	LC	
	LM	
	LV	
	EM	
	PL	
	PB	
	AC	

0276 - KIT 2 HOJAS S/CT 70

	SA	
	LB	54,27
	LC	54,27
	LM	
	LV	
	EM	
	PL	63,20
	PB	
	AC	64,73

0277 - KIT 15 VENTANAS S/CT 70

	SA	
	LB	742,90
	LC	742,90
	LM	
	LV	
	EM	
	PL	
	PB	
	AC	

0278 - TAPONES RECOJE AGÜAS CORREDERAS

	SA	2,53
	LB	2,77
	LC	2,77
	LM	
	LV	4,15
	EM	
	PL	
	PB	
	AC	

0281 - EMBELLECEDOR JUNQUILLO S/EURO

	SA	0,43
	LB	0,76
	LC	
	LM	3,40
	LV	1,27
	EM	2,00
	PL	1,54
	PB	
	AC	1,47

0282 - VÁLVULA DESAGÜE CORREDERA 100 UD.

	SA	
	LB	
	LC	5,52
	LM	
	LV	
	EM	
	PL	
	PB	
	AC	

0283 - CERROJO HOJA PASIVA S/EURO PALANCA

	SA	5,71
	LB	
	LC	
	LM	
	LV	
	EM	
	PL	
	PB	
	AC	

0284 - PERNIO DESMONTADO S/1400 Y 1450

	SA	3,13
	LB	2,98
	LC	2,98
	LM	
	LV	3,97
	EM	
	PL	6,93
	PB	
	AC	6,93

0285 - CONJUN. TAPON. INVERS. S/PRACTIC 45

	SA	
	LB	
	LC	1,24
	LM	
	LV	
	EM	
	PL	
	PB	
	AC	

0287 - PERNIO DH.90 MONT. EURO MONOBLOCK

	SA	
	LB	3,13
	LC	3,13
	LM	
	LV	
	EM	
	PL	
	PB	
	AC	

0288 - PERNIO IZ.90 MONT. EURO MONOBLOCK

	SA	
	LB	3,13
	LC	3,13
	LM	
	LV	
	EM	
	PL	
	PB	
	AC	

0289 - PERNIO DH. 90 MM. MONTADO EURO

	SA	
	LB	3,13
	LC	3,13
	LM	
	LV	3,54
	EM	
	PL	6,30
	PB	
	AC	6,30

ACCESORIOS - TARIFA PVP - GRUPO AYUSO

Fecha de entrada en vigor: 01-03-2007

Moneda: Euro

0290 - PERNIO IZ. 90 MM. MONTADO EURO		
	SA	
	LB	3,13
	LC	3,13
	LM	
	LV	3,30
	EM	
	PL	7,09
	PB	
	AC	6,30

0291 - PERNIO DH. 90 MM. MONTADO 1400-1450		
	SA	
	LB	3,33
	LC	3,33
	LM	
	LV	
	EM	
	PL	7,64
	PB	
	AC	7,64

0292 - PERNIO IZ. 90 MM. MONTADO 1400-1450		
	SA	
	LB	3,33
	LC	3,33
	LM	
	LV	
	EM	
	PL	7,64
	PB	
	AC	7,64

0293 - CONJ. TAPON INVE. PRATIC 40 REDONDO		
	SA	
	LB	
	LC	1,06
	LM	
	LV	
	EM	
	PL	
	PB	
	AC	

0330 - TORNILLO R/CHAPA 4.2 X 10 (200 UD,)		
	SA	5,19
	LB	
	LC	
	LM	
	LV	
	EM	
	PL	
	PB	
	AC	

0331 - TORNILLO R/CHAPA 4.2 X 19 (200 UD,)		
	SA	3,81
	LB	
	LC	
	LM	
	LV	
	EM	
	PL	
	PB	
	AC	

0332 - TORNILLO R/CHAPA 4.2 X 22 (200 UD,)		
	SA	4,75
	LB	
	LC	
	LM	
	LV	
	EM	
	PL	
	PB	
	AC	

0333 - TORNILLO R/CHAPA 3,5 X 25 (200 UD,)		
	SA	4,50
	LB	
	LC	
	LM	
	LV	
	EM	
	PL	
	PB	
	AC	

0334 - TORNILLO R/CHAPA 4.2 X 32 (200 UD,)		
	SA	6,53
	LB	
	LC	
	LM	
	LV	
	EM	
	PL	
	PB	
	AC	

0335 - TORNILLO R/CHAPA 4.8 X 25 (200 UD,)		
	SA	6,19
	LB	
	LC	
	LM	
	LV	
	EM	
	PL	
	PB	
	AC	

0336 - TO.R/CHAPA BROCA 4.2 X 16 (200 UD,)		
	SA	7,63
	LB	
	LC	
	LM	
	LV	
	EM	
	PL	
	PB	
	AC	

0338 - TORNILLO RO/CHAPA 5,5 X22 (200 UD,)		
	SA	8,31
	LB	
	LC	
	LM	
	LV	
	EM	
	PL	
	PB	
	AC	

0339 - TORNILLO RO/CHAPA 5,5 X32 (200 UD,)		
	SA	11,19
	LB	
	LC	
	LM	
	LV	
	EM	
	PL	
	PB	
	AC	

0340 - TORNILLO RO/CHAPA 5,5 X38 (200 UD,)		
	SA	11,97
	LB	
	LC	
	LM	
	LV	
	EM	
	PL	
	PB	
	AC	

0341 - TORNILLO RO/CHAPA 5,5 X60 (200 UD,)		
	SA	21,97
	LB	
	LC	
	LM	
	LV	
	EM	
	PL	
	PB	
	AC	

ACCESORIOS - TARIFA PVP - GRUPO AYUSO

Fecha de entrada en vigor: 01-03-2007

Moneda: Euro

0345 - TOR. 6X12 TENSOR OFICINA (200 UD.)

	SA	13,09
	LB	
	LC	
	LM	
	LV	
	EM	
	PL	
	PB	
	AC	

0346 - TORNILLO 6X12 ESCUADRAS (200 UD.)

	SA	15,59
	LB	
	LC	
	LM	
	LV	
	EM	
	PL	
	PB	
	AC	

0348 - TAPA TORNILLOS PVC. (200 UD.)

	SA	
	LB	5,38
	LC	5,38
	LM	
	LV	
	EM	
	PL	
	PB	
	AC	

0350 - T.INOX.5X12 CREMONA (500 UD.)

	SA	37,56
	LB	
	LC	
	LM	
	LV	
	EM	
	PL	
	PB	
	AC	

0351 - TORNILLO INOX. 5 X 8 (500 UD.)

	SA	28,19
	LB	
	LC	
	LM	
	LV	
	EM	
	PL	
	PB	
	AC	

0352 - T.INOX. PERNIO 5 X 9.5 (200 UD.)

	SA	12,01
	LB	
	LC	
	LM	
	LV	
	EM	
	PL	
	PB	
	AC	

0353 - TOR. INOX. 5X38 INVERSORA (200 UD.)

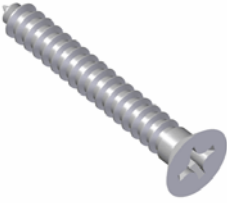
	SA	13,16
	LB	
	LC	
	LM	
	LV	
	EM	
	PL	
	PB	
	AC	

0354 - TORNILLO RUEDAS BAÑERA (500 UD.)

	SA	21,59
	LB	
	LC	
	LM	
	LV	
	EM	
	PL	
	PB	
	AC	

0373 - TORNILLO METRICA 8X25 MM.

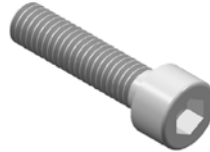
	SA	0,16
	LB	
	LC	
	LM	
	LV	
	EM	
	PL	
	PB	
	AC	

0400 - FELPUDO 7X6 100 MTR.

	SA	14,91
	LB	
	LC	
	LM	
	LV	
	EM	
	PL	
	PB	
	AC	

0402 - FELPUDO 7X7. FILM - SEAL 100 MTR.

	SA	35,28
	LB	
	LC	
	LM	
	LV	
	EM	
	PL	
	PB	
	AC	

0403 - FELPUDO 7X9 100 MTR.

	SA	19,03
	LB	
	LC	
	LM	
	LV	
	EM	
	PL	
	PB	
	AC	

0404 - FELPUDO 7X15 100 MTR.

	SA	57,75
	LB	
	LC	
	LM	
	LV	
	EM	
	PL	
	PB	
	AC	

0408 - FELPUDO 7 X 7 100 MTR.

	SA	19,04
	LB	
	LC	
	LM	
	LV	
	EM	
	PL	
	PB	
	AC	

0410 - GOMA CANUTILLO OFI. DOBLE 100 MTR.

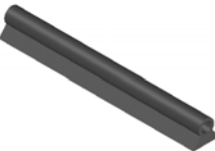
	SA	
	LB	
	LC	18,79
	LM	
	LV	
	EM	
	PL	
	PB	
	AC	

ACCESORIOS - TARIFA PVP - GRUPO AYUSO

Fecha de entrada en vigor: 01-03-2007

Moneda: Euro

0411 - FELPUDO VAIVEN 14 X 12

	SA	3,03
	LB	
	LC	
	LM	
	LV	
	EM	
	PL	
	PB	
	AC	

0412 - GOMA CUÑA GRANDE 100 MTR.

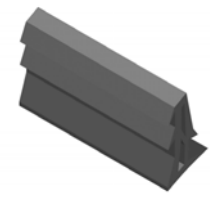
	SA	
	LB	
	LC	50,64
	LM	
	LV	
	EM	
	PL	
	PB	
	AC	

0414 - GOMA JUNTA S/1400 Y S/1450 100 MTR.

	SA	
	LB	
	LC	42,72
	LM	
	LV	
	EM	
	PL	
	PB	
	AC	

0416 - GOMA ACRI. GRANDE OFICINA 100 MTR.

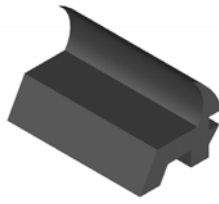
	SA	
	LB	
	LC	90,61
	LM	
	LV	
	EM	
	PL	
	PB	
	AC	

0417 - GOMA ACRI. PEQUEÑA OFICINA 100 MTR.

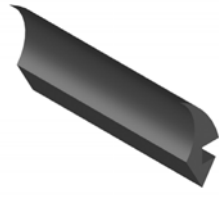
	SA	
	LB	
	LC	40,19
	LM	
	LV	
	EM	
	PL	
	PB	
	AC	

0418 - GRAPA ACERO DOBLE PANEL

	SA	0,37
	LB	
	LC	
	LM	
	LV	
	EM	
	PL	
	PB	
	AC	

0419 - ESCUADRA PERFILES 5383-5351-5

	SA	1,03
	LB	
	LC	
	LM	
	LV	
	EM	
	PL	
	PB	
	AC	

0420 - PERNIO MAMPARA DOBLE

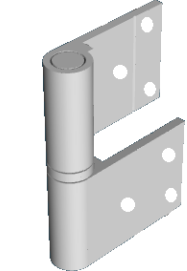
	SA	2,10
	LB	2,87
	LC	2,87
	LM	
	LV	
	EM	
	PL	2,70
	PB	
	AC	

0422 - GOMA HOJAS S/MAGNUM

	SA	
	LB	
	LC	1,03
	LM	
	LV	
	EM	
	PL	
	PB	
	AC	

0424 - GOMA OFI. PERFILES 5354 100 MTR.

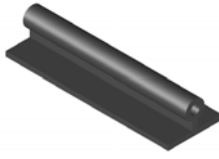
	SA	
	LB	
	LC	34,38
	LM	
	LV	
	EM	
	PL	
	PB	
	AC	

0425 - GOMA JUNTA 1400 Y 1450 100 MTR.

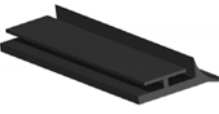
	SA	
	LB	
	LC	56,14
	LM	
	LV	
	EM	
	PL	
	PB	
	AC	

0427 - GOMA LAMA MALLORQUINA 100 MTR.

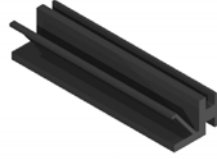
	SA	
	LB	
	LC	23,09
	LM	
	LV	
	EM	
	PL	
	PB	
	AC	

0450 - GOMA ACRIS. EXT. S/EUROPA 100 MTR.

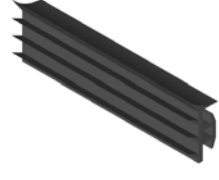
	SA	
	LB	
	LC	68,01
	LM	
	LV	
	EM	
	PL	
	PB	
	AC	

0451 - GOMA CERCO PLEGABLE 100 MTR.

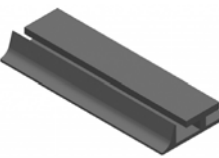
	SA	
	LB	
	LC	42,63
	LM	
	LV	
	EM	
	PL	
	PB	
	AC	

0452 - GOMA ESTANQ. CERCO S/EUROPA 100 MT.

	SA	
	LB	
	LC	98,64
	LM	
	LV	
	EM	
	PL	
	PB	
	AC	

ACCESORIOS - TARIFA PVP - GRUPO AYUSO

Fecha de entrada en vigor: 01-03-2007

Moneda: Euro

0453 - GOMA ESTANQ. H. S/EURO 100 MTR

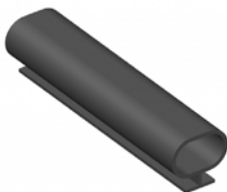
	SA	
	LB	
	LC	41,12
	LM	
	LV	
	EM	
	PL	
	PB	
	AC	

0455 - GOMA ESTANQ. CERCO S/PT 60 100 MTR.

	SA	
	LB	
	LC	139,44
	LM	
	LV	
	EM	
	PL	
	PB	
	AC	

0464 - GOMA CER. EXT. EUROPA 100 M

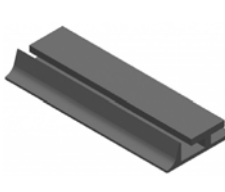
	SA	
	LB	
	LC	23,34
	LM	
	LV	
	EM	
	PL	
	PB	
	AC	

0465 - GOMA MOSQUITERA 100 MTR.

	SA	
	LB	
	LC	39,95
	LM	
	LV	
	EM	
	PL	
	PB	
	AC	

0466 - GOMA CUÑA PEQUEÑA 100 MTR.

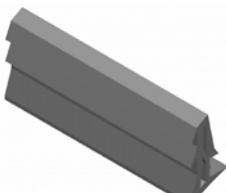
	SA	
	LB	
	LC	36,94
	LM	
	LV	
	EM	
	PL	
	PB	
	AC	

0467 - GOMA IMAN PARA BAÑERA

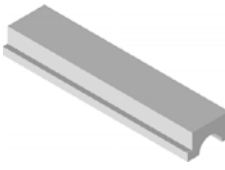
	SA	
	LB	
	LC	1,03
	LM	
	LV	
	EM	
	PL	
	PB	
	AC	

0472 - GOMA VERT. H.PLEGABLE 100 MTR

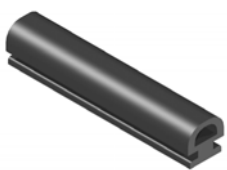
	SA	
	LB	
	LC	56,31
	LM	
	LV	
	EM	
	PL	
	PB	
	AC	

0473 - GOMA CENT.PLEGABLE 100 MTR.

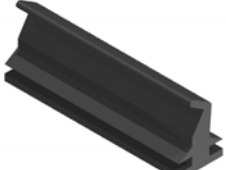
	SA	
	LB	
	LC	64,22
	LM	
	LV	
	EM	
	PL	
	PB	
	AC	

0474 - COMPLEMENTO PVC. H. CENTROS S/CT.70

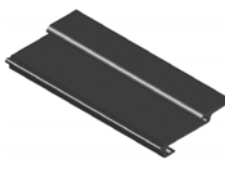
	SA	
	LB	
	LC	2,18
	LM	
	LV	
	EM	
	PL	
	PB	
	AC	

0476 - GOMA CERCO I/S. S/MAGNUM

	SA	
	LB	
	LC	1,66
	LM	
	LV	
	EM	
	PL	
	PB	
	AC	

0478 - COMPLEMENTO PVC. H.CENTROS S/MAGNUM

	SA	
	LB	
	LC	2,22
	LM	
	LV	
	EM	
	PL	
	PB	
	AC	

0507 - CONJUNTO MANILLAS ESC. RECUPERABLE

	SA	
	LB	13,66
	LC	13,66
	LM	
	LV	14,55
	EM	
	PL	20,57
	PB	
	AC	21,60

0509 - CERRADURA PIC+PA 25 MM.

	SA	33,88
	LB	
	LC	
	LM	
	LV	
	EM	
	PL	
	PB	
	AC	

0600 - CREMONA S/EUROPA 2 PATAS

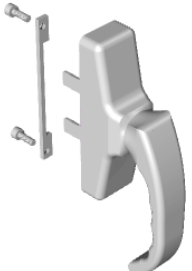
	SA	
	LB	10,72
	LC	10,72
	LM	
	LV	11,43
	EM	
	PL	18,69
	PB	
	AC	19,17

0600-104 - CREMONA S/EUROPA 2 PATAS

	SA	
	LB	10,19
	LC	10,19
	LM	
	LV	11,43
	EM	
	PL	18,55
	PB	
	AC	18,55

ACCESORIOS - TARIFA PVP - GRUPO AYUSO

Fecha de entrada en vigor: 01-03-2007

Moneda: Euro

0601 - KIT CIERRE PUNTOS S/ PLUS

	SA	
	LB	12,85
	LC	12,85
	LM	
	LV	
	EM	
	PL	15,84
	PB	
	AC	17,14

0602 - KIT PARA CREM. CIERRE PUNTOS S/PLUS

	SA	
	LB	
	LC	4,26
	LM	
	LV	
	EM	
	PL	
	PB	
	AC	

0603 - VARILLA CIERRE DE PUNTOS 1200 MM

	SA	2,73
	LB	
	LC	
	LM	
	LV	
	EM	
	PL	
	PB	
	AC	

0604 - BISAGRA DE PUERTA S/EUROPA

	SA	5,68
	LB	6,13
	LC	6,13
	LM	
	LV	7,67
	EM	
	PL	13,04
	PB	
	AC	13,04

0607 - TACO VENTANA S/EUROPA

	SA	0,60
	LB	
	LC	
	LM	
	LV	
	EM	
	PL	
	PB	
	AC	

0608 - TACO PUERTA S/EUROPA

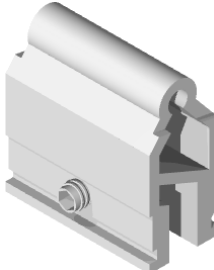
	SA	0,84
	LB	
	LC	
	LM	
	LV	
	EM	
	PL	
	PB	
	AC	

0609 - CONJUNTO TAPONES INVERSORA (TERMIC)

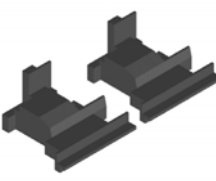
	SA	
	LB	
	LC	1,37
	LM	
	LV	
	EM	
	PL	
	PB	
	AC	

0613 - TAPA SALIDA DE AGUAS

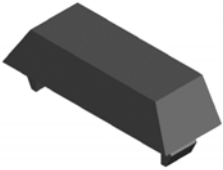
	SA	
	LB	
	LC	0,16
	LM	
	LV	
	EM	
	PL	
	PB	
	AC	

0616 - CONJUNTO PERNIOS PIVOTANTE S/EUROPA

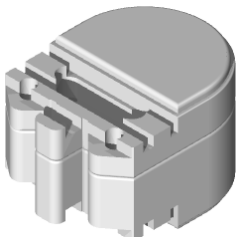
	SA	
	LB	63,67
	LC	63,67
	LM	
	LV	
	EM	
	PL	
	PB	
	AC	

0617 - TUBO PEGAMENTO

	SA	2,05
	LB	
	LC	
	LM	
	LV	
	EM	
	PL	
	PB	
	AC	

0619 - TUERCA EXCENTRICA

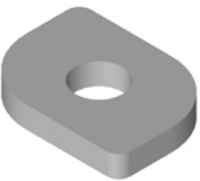
	SA	0,30
	LB	
	LC	
	LM	
	LV	
	EM	
	PL	
	PB	
	AC	

0620 - KIT PRACTICABLE 1 HOJA (TERMIC)

	SA	
	LB	33,86
	LC	33,86
	LM	
	LV	
	EM	
	PL	48,72
	PB	
	AC	49,17

0622 - KIT PRACTICABLE 2 HOJAS (TERMIC)

	SA	
	LB	47,21
	LC	47,21
	LM	
	LV	
	EM	
	PL	68,82
	PB	
	AC	69,27

0624 - RULETA DE METER GOMA

	SA	20,49
	LB	
	LC	
	LM	
	LV	
	EM	
	PL	
	PB	
	AC	













0625 - KIT 2 H. S/PLUS CIERRE PUNTOS

	SA	
	LB	55,47
	LC	55,47
	LM	
	LV	
	EM	
	PL	72,80
	PB	
	AC	75,40

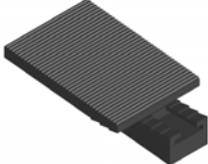
ACCESORIOS - TARIFA PVP - GRUPO AYUSO

Fecha de entrada en vigor: 01-03-2007

Moneda: Euro

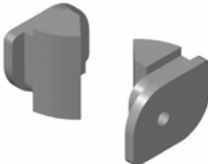
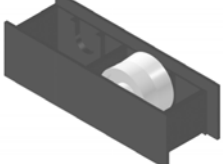
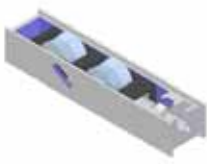
0626 - KIT 2 H. S/COR 2005			0627 - KIT 2 H. 15 V. S/COR 2005			0628 - KIT 2 H. S/COR 2005 CIERRE PUNTOS		
	SA			SA			SA	
	LB	47,88		LB	659,29		LB	57,09
	LC	47,88		LC	659,29		LC	57,09
	LM			LM			LM	
	LV			LV			LV	
	EM			EM			EM	
	PL	56,47		PL			PL	73,67
	PB			PB			PB	
	AC	58,00		AC			AC	76,27
0629 - KIT 3 HOJAS S/E. PLUS CIERRE PUNTOS			0630 - CONJUNTO CIERRES CREMONA S/EURO			0631 - KIT 2 HOJAS S/CT 70 CIERRE PUNTOS		
	SA			SA	8,12		SA	
	LB	72,34		LB			LB	64,97
	LC	72,34		LC	5,23		LC	64,97
	LM			LM			LM	
	LV			LV			LV	
	EM			EM			EM	
	PL	89,93		PL			PL	82,07
	PB			PB			PB	
	AC	92,53		AC			AC	84,67
0639 - CALZO CRISTAL (TERMIC)			0641 - CREMONA OSCILO S/EUROPA			0641-104 - CREMONA OSCILO S/EUROPA		
	SA			SA			SA	
	LB			LB	10,72		LB	10,19
	LC	0,47		LC	10,72		LC	10,19
	LM			LM			LM	
	LV			LV	12,25		LV	11,43
	EM			EM			EM	
	PL			PL	18,69		PL	18,55
	PB			PB			PB	
	AC			AC	19,17		AC	18,55
0646 - KIT PRACTICABLE 1 HOJA (PRACTIC)			0647 - KIT PRACTICABLE 2 HOJAS (PRACTIC)			0648 - CONJUNTO TAPONES INVERSORA (PRACTIC)		
	SA			SA			SA	
	LB	34,64		LB	47,95		LB	
	LC	34,64		LC	47,95		LC	1,33
	LM			LM			LM	
	LV			LV			LV	
	EM			EM			EM	
	PL	49,55		PL	69,62		PL	
	PB			PB			PB	
	AC	50,00		AC	70,07		AC	
0650 - CIERRE HOJA PASIVA			0651 - CARCASA RODAMIENTO S/EURO PLUS			0651-R - RODAMIENTO REGULABLE S/EURO PLUS		
	SA	1,23		SA			SA	
	LB			LB			LB	
	LC			LC	2,18		LC	4,76
	LM			LM			LM	
	LV			LV			LV	
	EM			EM			EM	
	PL			PL			PL	
	PB			PB			PB	
	AC			AC			AC	

ACCESORIOS - TARIFA PVP - GRUPO AYUSO

Fecha de entrada en vigor: 01-03-2007

Moneda: Euro

0652 - CARCASA SUPERIOR S/EUROPLUS

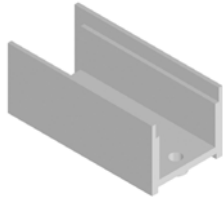
	SA	
	LB	
	LC	0,81
	LM	
	LV	
	EM	
	PL	
	PB	
	AC	

0653 - RODAMIENTO S/EURO PLUS

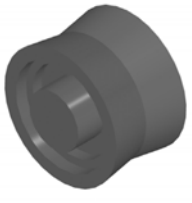
	SA	1,34
	LB	
	LC	
	LM	
	LV	
	EM	
	PL	
	PB	
	AC	

0654 - TOPE DE HOJAS S/PLUS

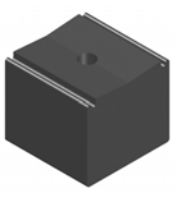
	SA	
	LB	
	LC	0,78
	LM	
	LV	
	EM	
	PL	
	PB	
	AC	

0656 - CORTAVIENTOS S/EUROPLUS

	SA	
	LB	
	LC	1,09
	LM	
	LV	
	EM	
	PL	
	PB	
	AC	

0657 - CLIPAJE HOJA CENTROS S/EUROPLUS

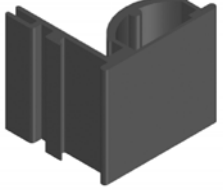
	SA	
	LB	
	LC	0,25
	LM	
	LV	
	EM	
	PL	
	PB	
	AC	

0657-B - COMPLEMENTO PVC. H. CENTRO S/PLUS

	SA	
	LB	
	LC	1,90
	LM	
	LV	
	EM	
	PL	
	PB	
	AC	

0658 - TAPA RANURAS H. CENTROS S/EUROPLUS

	SA	
	LB	0,44
	LC	0,44
	LM	
	LV	
	EM	
	PL	
	PB	
	AC	

0658-M - CONJ. 4 TAPAS H. CENT. PLUS MUELLE

	SA	
	LB	3,65
	LC	3,65
	LM	
	LV	
	EM	
	PL	
	PB	
	AC	

0659 - KIT 2 HOJAS S/EURO-PLUS

	SA	
	LB	52,28
	LC	52,28
	LM	
	LV	
	EM	
	PL	
	PB	
	AC	

0661 - TAPETA 4 HOJAS S/EUROPLUS

	SA	
	LB	0,28
	LC	0,28
	LM	
	LV	
	EM	
	PL	
	PB	
	AC	

0662 - CERROJO HOJA PASIVA S/EURO (2000)

	SA	
	LB	
	LC	4,84
	LM	
	LV	
	EM	
	PL	
	PB	
	AC	

0663 - ASA TIRADOR S/EURO-PLUS

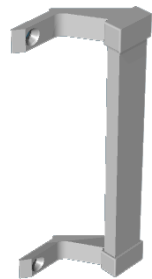
	SA	3,34
	LB	4,29
	LC	4,29
	LM	
	LV	
	EM	
	PL	5,13
	PB	
	AC	5,13

0664 - ESCUADRA GOMA S/TERMIC-PRACT-PT.50

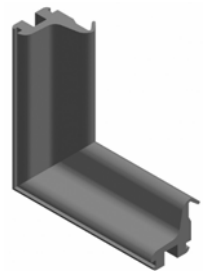
	SA	
	LB	
	LC	0,34
	LM	
	LV	
	EM	
	PL	
	PB	
	AC	

0665 - ESCUADRA ALINEACION INGLETE

	SA	0,29
	LB	
	LC	
	LM	
	LV	
	EM	
	PL	
	PB	
	AC	













0666 - KIT S/EUROCOR 2 HOJAS 54

	SA	
	LB	44,50
	LC	44,50
	LM	
	LV	
	EM	
	PL	
	PB	
	AC	

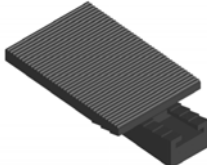
ACCESORIOS - TARIFA PVP - GRUPO AYUSO

Fecha de entrada en vigor: 01-03-2007

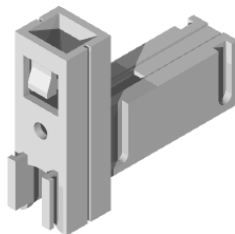
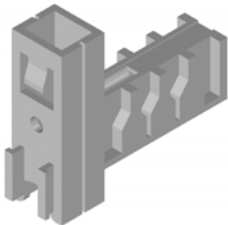
Moneda: Euro

0670 - KIT S/EUROCOR 15 VENTANAS			0673 - KIT 1 HOJA S/EUROTHERMIC 15 VENTANAS			0674 - KIT 2 HOJAS S/EUROTHERMIC 15 VENTANA		
	SA			SA			SA	
	LB	798,44		LB	448,79		LB	634,42
	LC	798,44		LC	448,79		LC	634,42
	LM			LM			LM	
	LV			LV			LV	
	EM			EM			EM	
	PL			PL			PL	
	PB			PB			PB	
	AC			AC			AC	
0675 - KIT 1 HOJA S/EUROPRACTIC 15 VENTANA			0676 - KIT 2 HOJAS S/EUROPRACTIC 15 VENTAN			0677 - KIT S/EUROPLUS 15 VENTANAS		
	SA			SA			SA	
	LB	444,59		LB	644,88		LB	738,03
	LC	444,59		LC	644,88		LC	738,03
	LM			LM			LM	
	LV			LV			LV	
	EM			EM			EM	
	PL			PL			PL	
	PB			PB			PB	
	AC			AC			AC	
0678 - CALZO CRISTAL (PRACTIC)			0679 - CONJUNTO CERRADURA S/EUROPA			0680 - CIERRE EMBUTIDO PULSADOR		
	SA			SA	111,06		SA	
	LB			LB			LB	8,28
	LC	0,47		LC			LC	8,28
	LM			LM			LM	
	LV			LV			LV	8,84
	EM			EM			EM	
	PL			PL			PL	11,53
	PB			PB			PB	
	AC			AC			AC	12,30
0683 - KIT PAREJA PUNTOS CIERRE CERRADURA			0690 - CIERRE STAR 60			0691 - CARCASA SUPERIOR FIJA STAR 60		
	SA	67,50		SA			SA	0,41
	LB			LB	3,60		LB	
	LC			LC	3,60		LC	
	LM			LM			LM	
	LV			LV	3,84		LV	
	EM			EM			EM	
	PL			PL	6,34		PL	
	PB			PB			PB	
	AC			AC	6,61		AC	
0692 - CARCASA INFERIOR FIJA STAR 60			0693 - REMATES EMBELLECEDORES STAR 60			0694 - CORTAVIENTOS SUPERIOR STAR 60/73		
	SA	0,94		SA			SA	0,31
	LB			LB	0,47		LB	
	LC			LC	0,47		LC	
	LM			LM			LM	
	LV			LV			LV	
	EM			EM			EM	
	PL			PL			PL	
	PB			PB			PB	
	AC			AC			AC	

ACCESORIOS - TARIFA PVP - GRUPO AYUSO

Fecha de entrada en vigor: 01-03-2007

Moneda: Euro

0695 - CORTAVIENTOS INFERIOR STAR 60

	SA	0,20
	LB	
	LC	
	LM	
	LV	
	EM	
	PL	
	PB	
	AC	

0696 - JUNTAS CERCO INFERIOR STAR 60

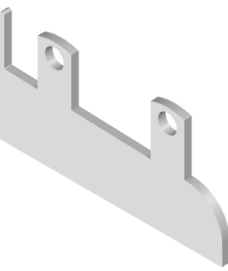
	SA	0,22
	LB	
	LC	
	LM	
	LV	
	EM	
	PL	
	PB	
	AC	

0697 - RODAMIENTO STAR 60

	SA	0,66
	LB	
	LC	
	LM	
	LV	
	EM	
	PL	
	PB	
	AC	

0698 - ESCUADRA SOLAPE

	SA	0,37
	LB	
	LC	
	LM	
	LV	
	EM	
	PL	
	PB	
	AC	

0699 - ESCUADRA FIJOS STAR 60

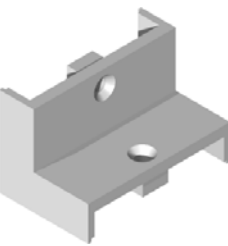
	SA	2,09
	LB	
	LC	
	LM	
	LV	
	EM	
	PL	
	PB	
	AC	

0700 - KIT 2 HOJAS STAR 60 RUEDA FIJA

	SA	
	LB	16,98
	LC	16,98
	LM	
	LV	
	EM	
	PL	
	PB	
	AC	

0702 - KIT 15 VENTANAS STAR 60 RUEDA FIJA

	SA	
	LB	239,62
	LC	239,62
	LM	
	LV	
	EM	
	PL	
	PB	
	AC	

0706 - ENGANCHE CREMONA PVC COMPLETO

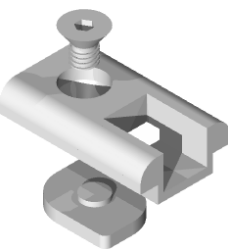
	SA	1,10
	LB	
	LC	
	LM	
	LV	
	EM	
	PL	
	PB	
	AC	

0708 - GRAPA JUNQUILLO REDONDO (100 UND.)

	SA	13,84
	LB	
	LC	
	LM	
	LV	
	EM	
	PL	
	PB	
	AC	

0709 - KIT 2 HOJAS STAR 60 RUEDA REGULABLE

	SA	
	LB	25,70
	LC	25,70
	LM	
	LV	
	EM	
	PL	
	PB	
	AC	

0711 - KIT 15 VENTANAS STAR 60 REGULABLE

	SA	
	LB	362,62
	LC	362,62
	LM	
	LV	
	EM	
	PL	
	PB	
	AC	

0727 - CARCASA STAR 73 SUPERIOR REGULABLE

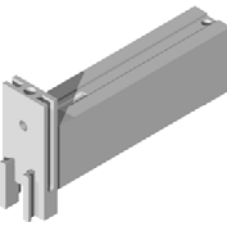
	SA	1,03
	LB	
	LC	
	LM	
	LV	
	EM	
	PL	
	PB	
	AC	

0728 - CARCASA STAR 73 INFERIOR REGULABLE

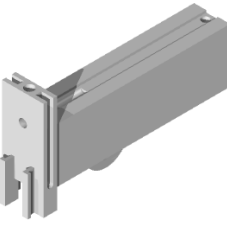
	SA	2,93
	LB	
	LC	
	LM	
	LV	
	EM	
	PL	
	PB	
	AC	

0729 - REMATES EMBELLECEDOR STAR 73

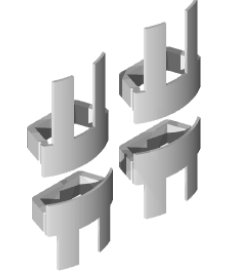
	SA	
	LB	0,66
	LC	0,66
	LM	
	LV	
	EM	
	PL	
	PB	
	AC	

0730 - CORTAVIENTOS INFERIOR STAR 73

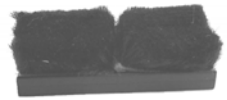
	SA	0,81
	LB	
	LC	
	LM	
	LV	
	EM	
	PL	
	PB	
	AC	

ACCESORIOS - TARIFA PVP - GRUPO AYUSO

Fecha de entrada en vigor: 01-03-2007

Moneda: Euro

0731 - JUNTAS CERCO STAR 73

	SA	0,22
	LB	
	LC	
	LM	
	LV	
	EM	
	PL	
	PB	
	AC	

0732 - RODAMIENTO STAR 73

	SA	0,89
	LB	
	LC	
	LM	
	LV	
	EM	
	PL	
	PB	
	AC	

0733 - KIT 2 HOJAS STAR 73 RUEDA REGULABLE

	SA	
	LB	33,88
	LC	33,88
	LM	
	LV	
	EM	
	PL	
	PB	
	AC	

0735 - KIT 15 VENTANAS STAR 73 RUEDA REGUL

	SA	
	LB	478,24
	LC	478,24
	LM	
	LV	
	EM	
	PL	
	PB	
	AC	

0736 - BISAGRA S/PLEGABLE

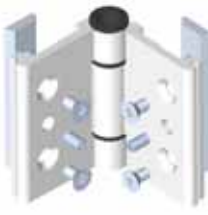
	SA	
	LB	8,65
	LC	8,65
	LM	
	LV	
	EM	
	PL	
	PB	
	AC	

0737 - CONJUNTO RUEDA PATIN S/PLEGABLE

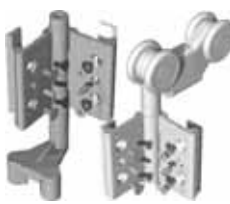
	SA	
	LB	44,03
	LC	44,03
	LM	
	LV	
	EM	
	PL	
	PB	
	AC	

0739 - VARILLA ROSCADA 6 X 1200 MM.

	SA	2,30
	LB	
	LC	
	LM	
	LV	
	EM	
	PL	
	PB	
	AC	

0740 - VARILLA ROSCADA 6 X 1500 MM.

	SA	4,60
	LB	
	LC	
	LM	
	LV	
	EM	
	PL	
	PB	
	AC	

0741 - ESCUADRA S/EURO PLEGABLE

	SA	1,26
	LB	
	LC	
	LM	
	LV	
	EM	
	PL	
	PB	
	AC	

0742 - TIRADOR S/EURO PLEGABLE

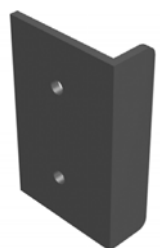
	SA	
	LB	
	LC	3,70
	LM	
	LV	
	EM	
	PL	
	PB	
	AC	

0743 - PASADOR DOBLE EFECTO S/EURO PLEGABL

	SA	
	LB	
	LC	18,96
	LM	
	LV	
	EM	
	PL	
	PB	
	AC	

0744 - TACO UNION CERCO CON GUIA SUPERIOR

	SA	0,83
	LB	
	LC	
	LM	
	LV	
	EM	
	PL	
	PB	
	AC	

0745 - KIT 2 HOJAS STAR 73 RUEDA FIJA

	SA	
	LB	27,13
	LC	27,13
	LM	
	LV	
	EM	
	PL	
	PB	
	AC	

0746 - KIT 15 VENTANAS STAR 73 RUEDA FIJA

	SA	
	LB	382,88
	LC	382,88
	LM	
	LV	
	EM	
	PL	
	PB	
	AC	

0747 - TAPETA STAR 60

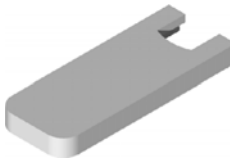
	SA	
	LB	0,13
	LC	0,13
	LM	
	LV	
	EM	
	PL	
	PB	
	AC	

ACCESORIOS - TARIFA PVP - GRUPO AYUSO

Fecha de entrada en vigor: 01-03-2007

Moneda: Euro

0748 - TAPETA STAR 73		
	SA	
	LB	0,13
	LC	0,13
	LM	
	LV	
	EM	
	PL	
	PB	
	AC	

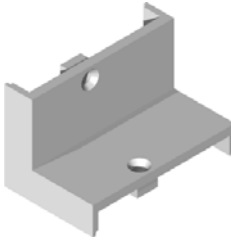
0752 - ESCUADRA FIJOS STAR 73		
	SA	2,74
	LB	
	LC	
	LM	
	LV	
	EM	
	PL	
	PB	
	AC	

0753 - CIERRE ALUMINIO STAR 73 BALANCIN		
	SA	
	LB	5,07
	LC	5,07
	LM	
	LV	
	EM	
	PL	
	PB	
	AC	

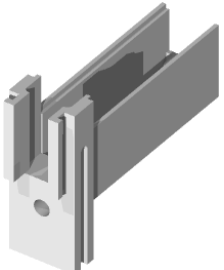
0754 - CARCASA SUPERIOR REGULABLE STAR 60		
	SA	0,81
	LB	
	LC	
	LM	
	LV	
	EM	
	PL	
	PB	
	AC	

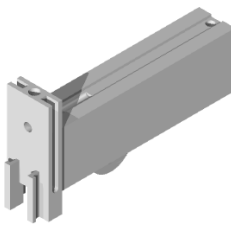
0755 - CARCASA INFERIOR REGULABLE STAR 60		
	SA	2,51
	LB	
	LC	
	LM	
	LV	
	EM	
	PL	
	PB	
	AC	

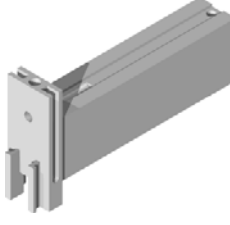
0756 - CARCASA SUPERIOR FIJA STAR 73		
	SA	0,75
	LB	
	LC	
	LM	
	LV	
	EM	
	PL	
	PB	
	AC	

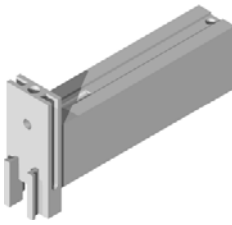
0757 - CARCASA INFERIOR FIJA STAR 73		
	SA	1,65
	LB	
	LC	
	LM	
	LV	
	EM	
	PL	
	PB	
	AC	

0758 - PAREJA TESTEROS CAJON PERSIANA		
	SA	16,99
	LB	18,56
	LC	18,56
	LM	
	LV	
	EM	
	PL	
	PB	
	AC	

0759 - EMBELLECEDOR PARA BATIENTE 1687		
	SA	
	LB	
	LC	0,47
	LM	
	LV	
	EM	
	PL	
	PB	
	AC	

0780 - CIERRE ALUMINIO STAR 73 MUELLE		
	SA	
	LB	5,07
	LC	5,07
	LM	
	LV	5,40
	EM	
	PL	8,80
	PB	
	AC	9,37

0781 - KIT 2 H. STAR 73 RU/RE. CIER/MUELLE		
	SA	
	LB	33,89
	LC	33,89
	LM	
	LV	
	EM	
	PL	
	PB	
	AC	

0783 - KIT 15 V. STAR 73 RU/RE. CIERRE MUELL		
	SA	
	LB	478,24
	LC	478,24
	LM	
	LV	
	EM	
	PL	
	PB	
	AC	

0784 - KIT 2 H. STAR 73 RU/FI. CIERRE MUELLE		
	SA	
	LB	27,13
	LC	27,13
	LM	
	LV	
	EM	
	PL	
	PB	
	AC	

0786 - KIT 15 V. STAR 73 RU/FI. CIERRE MUELL		
	SA	
	LB	394,48
	LC	394,48
	LM	
	LV	
	EM	
	PL	
	PB	
	AC	

0791 - KIT 2 HOJAS S/PRACTIC CAMARA 11 MM.		
	SA	
	LB	46,40
	LC	46,40
	LM	
	LV	
	EM	
	PL	67,95
	PB	
	AC	68,40

ACCESORIOS - TARIFA PVP - GRUPO AYUSO

Fecha de entrada en vigor: 01-03-2007

Moneda: Euro

0792 - KIT 1 HOJA S/PRACTIC CAMARA 11 MM.

	SA	
	LB	33,34
	LC	33,34
	LM	
	LV	
	EM	
	PL	48,16
	PB	
	AC	48,61

0793 - KIT S/PRACTIC 2 H.15 V.CAMARA 11MM.

	SA	
	LB	623,06
	LC	623,06
	LM	
	LV	
	EM	
	PL	
	PB	
	AC	

0794 - KIT S/PRACTIC 1 H.15 V.CAMARA 11MM.

	SA	
	LB	443,52
	LC	443,52
	LM	
	LV	
	EM	
	PL	
	PB	
	AC	

0795 - CIERRE GOLPETE S/EURO

	SA	
	LB	6,40
	LC	6,40
	LM	
	LV	
	EM	
	PL	
	PB	
	AC	

0796 - COMPAS BASCULANTE 220 MM. S/EURO

	SA	6,57
	LB	
	LC	
	LM	
	LV	
	EM	
	PL	
	PB	
	AC	

0797 - COMPAS BASCULANTE 150 MM. S/EURO

	SA	6,33
	LB	
	LC	
	LM	
	LV	
	EM	
	PL	
	PB	
	AC	

0798 - KIT 3 HOJAS S/EURO PLUS

	SA	
	LB	61,56
	LC	61,56
	LM	
	LV	
	EM	
	PL	71,07
	PB	
	AC	72,60

1012 - UTIL EUROPA PRACTICABLE

	SA	1.442,21
	LB	
	LC	
	LM	
	LV	
	EM	
	PL	
	PB	
	AC	

1028 - UTIL STAR 60

	SA	1.300,15
	LB	
	LC	
	LM	
	LV	
	EM	
	PL	
	PB	
	AC	

1035 - UTIL S/ PLUS Y COR

	SA	1.111,76
	LB	
	LC	
	LM	
	LV	
	EM	
	PL	
	PB	
	AC	

1042 - TROQUEL ESCUADRAS S/PLUS 3 HOJAS

	SA	595,00
	LB	
	LC	
	LM	
	LV	
	EM	
	PL	
	PB	
	AC	

1044 - UTIL S/EURO PER

	SA	1.401,09
	LB	
	LC	
	LM	
	LV	
	EM	
	PL	
	PB	
	AC	

1046 - UTIL DE MECANIZAR CIERRES DE PUNTOS

	SA	836,91
	LB	
	LC	
	LM	
	LV	
	EM	
	PL	
	PB	
	AC	

1049 - UTIL CIERRE EMBUTIDO STAR 60

	SA	843,09
	LB	
	LC	
	LM	
	LV	
	EM	
	PL	
	PB	
	AC	









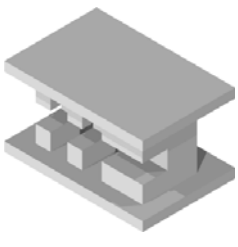

1051 - UTIL COMPACTO STAR 60

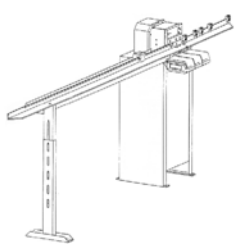
	SA	1.337,21
	LB	
	LC	
	LM	
	LV	
	EM	
	PL	
	PB	
	AC	

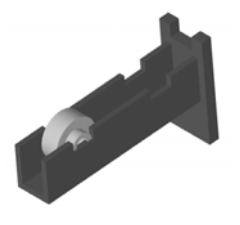
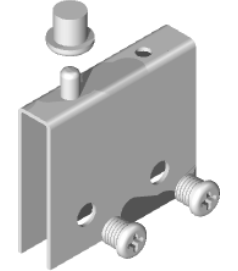
ACCESORIOS - TARIFA PVP - GRUPO AYUSO

Fecha de entrada en vigor: 01-03-2007















Moneda: Euro

1052 - UTIL STAR 73			1053 - UTIL COMPACTO STAR 73			1055 - UTIL CIERRE EMBUTIDO STAR 73		
	SA	1.232,21		SA	1.448,38		SA	843,09
	LB			LB			LB	
	LC			LC			LC	
	LM			LM			LM	
	LV			LV			LV	
	EM			EM			EM	
	PL			PL			PL	
	PB			PB			PB	
	AC			AC			AC	
1089 - MAQUINA MONTAJE OSCILO			1091 - TROQUEL CIERRES STAR 60-73			2700 - CERRADURA PUERTA		
	SA	4.872,73		SA	955,88		SA	15,82
	LB			LB			LB	
	LC			LC			LC	
	LM			LM			LM	
	LV			LV			LV	
	EM			EM			EM	
	PL			PL			PL	
	PB			PB			PB	
	AC			AC			AC	
2704 - RUEDAS VITRINA			2708 - BISAGRA PUERTA ABATIBLE			2907 - MALLORQUINA 7 LAMAS 460		
	SA			SA	2,50		SA	
	LB			LB			LB	
	LC	0,72		LC			LC	23,74
	LM			LM			LM	
	LV			LV			LV	
	EM			EM			EM	
	PL			PL			PL	
	PB			PB			PB	
	AC			AC			AC	
2908 - MALLORQUINA 8 LAMAS 515			2909 - MALLORQUINA 9 LAMAS 570			2910 - MALLORQUINA 10 LAMAS 625		
	SA			SA			SA	
	LB			LB			LB	
	LC	27,07		LC	30,44		LC	33,85
	LM			LM			LM	
	LV			LV			LV	
	EM			EM			EM	
	PL			PL			PL	
	PB			PB			PB	
	AC			AC			AC	
2911 - MALLORQUINA 11 LAMAS 680			2912 - MALLORQUINA 12 LAMAS 735			2913 - MALLORQUINA 13 LAMAS 790		
	SA			SA			SA	
	LB			LB			LB	
	LC	37,26		LC	40,59		LC	44,00
	LM			LM			LM	
	LV			LV			LV	
	EM			EM			EM	
	PL			PL			PL	
	PB			PB			PB	
	AC			AC			AC	

ACCESORIOS - TARIFA PVP - GRUPO AYUSO

Fecha de entrada en vigor: 01-03-2007

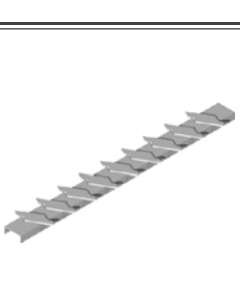
Moneda: Euro

2914 - MALLORQUINA 14 LAMAS 845			2915 - MALLORQUINA 15 LAMAS 900			2916 - MALLORQUINA 16 LAMAS 955		
	SA			SA			SA	
	LB			LB			LB	
	LC	47,41		LC	50,74		LC	54,19
	LM			LM			LM	
	LV			LV			LV	
	EM			EM			EM	
	PL			PL			PL	
	PB			PB			PB	
	AC			AC			AC	
2917 - MALLORQUINA 17 LAMAS 1010			2918 - MALLORQUINA 18 LAMAS 1065			2919 - MALLORQUINA 19 LAMAS 1120		
	SA			SA			SA	
	LB			LB			LB	
	LC	58,81		LC	62,26		LC	65,74
	LM			LM			LM	
	LV			LV			LV	
	EM			EM			EM	
	PL			PL			PL	
	PB			PB			PB	
	AC			AC			AC	
2920 - MALLORQUINA 20 LAMAS 1175			2921 - MALLORQUINA 21 LAMAS 1230			2922 - MALLORQUINA 22 LAMAS 1285		
	SA			SA			SA	
	LB			LB			LB	
	LC	69,33		LC	72,63		LC	76,11
	LM			LM			LM	
	LV			LV			LV	
	EM			EM			EM	
	PL			PL			PL	
	PB			PB			PB	
	AC			AC			AC	
2923 - MALLORQUINA 23 LAMAS 1340			2924 - MALLORQUINA 24 LAMAS 1395			2925 - MALLORQUINA 25 LAMAS 1450		
	SA			SA			SA	
	LB			LB			LB	
	LC	79,56		LC	81,22		LC	84,59
	LM			LM			LM	
	LV			LV			LV	
	EM			EM			EM	
	PL			PL			PL	
	PB			PB			PB	
	AC			AC			AC	
2926 - MALLORQUINA 26 LAMAS 1505			2927 - MALLORQUINA 27 LAMAS 1560			2928 - MALLORQUINA 28 LAMAS 1615		
	SA			SA			SA	
	LB			LB			LB	
	LC	88,00		LC	91,33		LC	94,78
	LM			LM			LM	
	LV			LV			LV	
	EM			EM			EM	
	PL			PL			PL	
	PB			PB			PB	
	AC			AC			AC	

ACCESORIOS - TARIFA PVP - GRUPO AYUSO

Fecha de entrada en vigor: 01-03-2007

Moneda: Euro

2929 - MALLORQUINA 29 LAMAS 1670			2930 - MALLORQUINA 30 LAMAS 1725			2931 - MALLORQUINA 31 LAMAS 1780		
	SA			SA			SA	
	LB			LB			LB	
	LC	98,15		LC	101,56		LC	104,93
	LM			LM			LM	
	LV			LV			LV	
	EM			EM			EM	
	PL			PL			PL	
	PB			PB			PB	
	AC			AC			AC	
2932 - MALLORQUINA 32 LAMAS 1835			2933 - MALLORQUINA 33 LAMAS 1890			2934 - MALLORQUINA 34 LAMAS 1945		
	SA			SA			SA	
	LB			LB			LB	
	LC	108,30		LC	111,70		LC	116,37
	LM			LM			LM	
	LV			LV			LV	
	EM			EM			EM	
	PL			PL			PL	
	PB			PB			PB	
	AC			AC			AC	
2935 - MALLORQUINA 35 LAMAS 2000			2936 - MALLORQUINA 62 LAMAS 3220			2937 - ROTOR DE MALLORQUINA ORIENTABLE		
	SA			SA			SA	
	LB			LB			LB	
	LC	119,78		LC	183,97		LC	3,33
	LM			LM			LM	
	LV			LV			LV	
	EM			EM			EM	
	PL			PL			PL	
	PB			PB			PB	
	AC			AC			AC	
5009 - SOPORTE LUNAS REGULABLE			5015 - ESCUADRA INGLETE INTERIOR S/5000 Y			5016 - ESCUADRA INGLETE EXTERIOR S/5000 Y		
	SA	1,88		SA	2,09		SA	2,00
	LB			LB			LB	
	LC			LC			LC	
	LM			LM			LM	
	LV			LV			LV	
	EM			EM			EM	
	PL			PL			PL	
	PB			PB			PB	
	AC			AC			AC	
5056 - CARRIL INFE. VITRINA PVC S/5050			5057 - CARRIL SUP. VITRINA PVC S/5050			5058 - JUNQUI. (CONJUNTO) PVC S/5050		
	SA			SA			SA	
	LB			LB			LB	
	LC	1,40		LC	1,53		LC	3,08
	LM			LM			LM	
	LV			LV			LV	
	EM			EM			EM	
	PL			PL			PL	
	PB			PB			PB	
	AC			AC			AC	

ACCESORIOS - TARIFA PVP - GRUPO AYUSO

Fecha de entrada en vigor: 01-03-2007

Moneda: Euro

5059 - TAPA RANURAS /5050

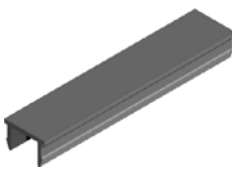
	SA	
	LB	1,23
	LC	1,23
	LM	
	LV	
	EM	
	PL	
	PB	1,23
	AC	

5060 - GRAPA UNION TRAVESAÑOS S/5050

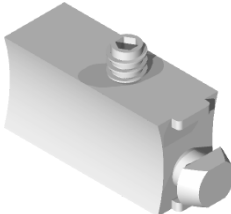
	SA	2,91
	LB	
	LC	
	LM	
	LV	
	EM	
	PL	
	PB	
	AC	

5061 - TAPA PARA PATAS PVC S/5050

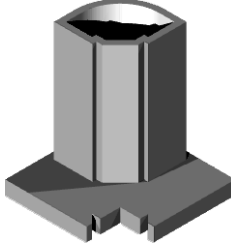
	SA	
	LB	
	LC	0,33
	LM	
	LV	
	EM	
	PL	
	PB	
	AC	

5062 - NUDO D/5050

	SA	
	LB	6,69
	LC	6,69
	LM	
	LV	
	EM	
	PL	
	PB	7,03
	AC	7,75



ALUMINIOS AYUSO, S.L.

EXTRALUMIN, S.A.

ALUMITRAN, S.A.

CLIMACRI, S.A.

ALUSISTEMAS JAEN

EBORA ALUMINIO, S.L.

AYUSO 3 BURGOS, S.L.

NUEVO PERFIL, S.A.

ALUSISTEMAS SEVILLA

AYUSO 4 ZAMORA, S.L.



ANODIZADOS AYUSO, S.L.

CODIALUM ALBACETE, S.L.

J. CANTARERO, S.L.

ALUSISTEMAS GRANADA

ADISA

ALUGISA, S.L.

AYUSO 2, S.A.

ALUSISTEMAS MALAGA

JORVE BALEAR, S.A.

AYUSO 5 MURCIA, S.L.